

Think Automation and beyond...



FT1A Controller



SmartAXIS







Touch

Built-in LCD enables control and display

Pro/Lite

User-friendly interface for use in various applications

SmartAXIS Selection Guide

Specifications		Touch		Pro									
		 Color LCD	 Monochrome LCD										
Part No.		FT1A-*12RA-□		FT1A-H12RA	FT1A-H12RC	FT1A-H24RA	FT1A-H24RC	FT1A-H40RKA	FT1A-H40RSA	FT1A-H40RC			
Power Voltage		24V DC		24V DC	100-240V AC	24V DC	100-240V AC	24V DC	24V DC	100-240V AC			
No. of Inputs	Digital	6 points		6 points	8 points	12 points	16 points	18 points	18 points	24 points			
	Analog (digital compatible)	2 points		2 points	—	4 points	—	6 points	6 points	—			
No. of outputs	Transistor (sink output)		—	—	—	—	—	4 points	—	—			
	Transistor (source output)		—	—	—	—	—	—	4 points	—			
	Relay output	10A relay	4 points		4 points	4 points	4 points	4 points	4 points	4 points	4 points		
		2A relay	—		—	—	4 points	4 points	8 points	8 points	12 points		
Program Capacity		48KB Configuration Memory Capacity: 5MB		12KB		48KB		48KB					
Instructions Processing Time	Basic Instruction	1,850μs/1,000 steps		950μs/1,000 steps									
	END Processing	5ms minimum		2ms									
(Maximum Counter Frequency and Points)	Single/two-phase selectable	1 point (5kHz, 2/4-edge, no single-phase use)		2 points (Note 1)	—	2 points (Note 1)	—	2 points (Note 1)	—	—			
	Single-phase	4 points (×10kHz)		2 points (×100kHz)	—	4 points (×100kHz)	—	4 points (×100kHz)	—	—			
Pulse Output	100kHz	—		—		—		2 points	2 points	—			
	5kHz	—		—		—		2 points	2 points	—			
Interface	USB Port		2 (USB-A, USB-miniB)		1 (Note 2)		1 (Note 2)		1 (Note 2)				
	Ethernet		1		—		1		1				
	Expansion Communication Ports		—		—		1		2				
			RS232C		1		—		1 max. (Note 3)		2 max. (Note 3)		
			RS422/485		1		—		1 max. (Note 3)		2 max. (Note 3)		
	SD Memory Card		—		—		—		1 (Note 4)				
Memory Cartridge		—		1		1		1					
Clock Function		✓		✓		✓		✓					
LCD		TFT color (65,536 colors) STN monochrome (pink/red/white backlight)		✓ (STN monochrome)		✓ (STN monochrome)		✓ (STN monochrome)					
Page		4		6		6		6					

* LCD: M (STN monochrome), C (TFT color) □ Bezel color: W (light gray), B (dark gray), S (silver)
 Note 1: Single-phase: 100kHz, two-phase: 50kHz, 2/4-edge Note 2: USB-miniB (maintenance port)
 Note 3: When expansion communication cartridge is installed. Note 4: SD memory card: 32GB max.

	Pro				Lite											
	48				12		24		40			48				
	FT1A-H48KA	FT1A-H48SA	FT1A-H48KC	FT1A-H48SC	FT1A-B12RA	FT1A-B12RC	FT1A-B24RA	FT1A-B24RC	FT1A-B40RKA	FT1A-B40RSA	FT1A-B40RC	FT1A-B48KA	FT1A-B48SA	FT1A-B48KC	FT1A-B48SC	
	24V DC	24V DC	100-240V AC	100-240V AC	24V DC	100-240V AC	24V DC	100-240V AC	24V DC	24V DC	100-240V AC	24V DC	24V DC	100-240V AC	100-240V AC	
	22 points	22 points	30 points	30 points	6 points	8 points	12 points	16 points	18 points	18 points	24 points	22 points	22 points	30 points	30 points	
	8 points	8 points	—	—	2 points	—	4 points	—	6 points	6 points	—	8 points	8 points	—	—	
	18 points	—	18 points	—	—	—	—	—	4 points	—	—	18 points	—	18 points	—	
	—	18 points	—	18 points	—	—	—	—	—	4 points	—	—	18 points	—	18 points	
	—	—	—	—	4 points	4 points	4 points	4 points	4 points	4 points	4 points	—	—	—	—	
	—	—	—	—	—	—	4 points	4 points	8 points	8 points	12 points	—	—	—	—	
	48KB				12KB		48KB		48KB			48KB				
	950µs/1,000 steps				950µs/1,000 steps											
	2ms				640µs											
	2 points (Note 1)		—		2 points (Note 1)	—	2 points (Note 1)	—	2 points (Note 1)		—	2 points (Note 1)		—		
	4 points (x100kHz)		—		2 points (x100kHz)	—	4 points (x100kHz)	—	4 points (x100kHz)		—	4 points (x100kHz)		—		
	2 points	2 points	2 points	2 points	—		—		2 points	2 points	—	2 points	2 points	2 points	2 points	
	2 points	2 points	2 points	2 points	—		—		2 points	2 points	—	2 points	2 points	2 points	2 points	
	1 (Note 2)				1 (Note 2)		1 (Note 2)		1 (Note 2)			1 (Note 2)				
	1				—		1		1			1				
	2				—		1		2			2				
	2 max. (Note 3)				—		1 max. (Note 3)		2 max. (Note 3)			2 max. (Note 3)				
	2 max. (Note 3)				—		1 max. (Note 3)		2 max. (Note 3)			2 max. (Note 3)				
	1 (Note 4)				—		—		1 (Note 4)			1 (Note 4)				
	1				1		1		1			1				
	✓				✓		✓		✓			✓				
	✓ (STN monochrome)				—		—		—			—				
	6				6		6		6			6				

SmartAXIS Touch

FT1A Controller



Small vivid LED display

Save installation space, wire, and time.

Touch is an advanced, 3.8-inch display with integrated control and monitor functions. A bright LED backlight provides a vivid display.

Actual Size



Control Functions

Fast Processing Speed

Stable and efficient processing

Basic instructions processing time: 1850μs/1000 steps. Fast processing time is available in the integrated control function.

10A Relay

No external relay, reducing wiring

Max. 10A output enables direct operation of solenoid valves. No additional circuit necessary to connect a relay, reducing wiring.



USB Flash Drive

Easy log data saving

Integrated data logging function using an USB memory. Programs can also be changed easily.



High Speed

High-speed counter

Fast counter (single-phase 10 kHz/4 point, two-phase 5 kHz/1 point).

Memory

Large memory size enables stress-free programming of easy-to-see screen

Stress-free programming with large memory size - 48KB program size and 5MB configuration memory capacity.

Structure

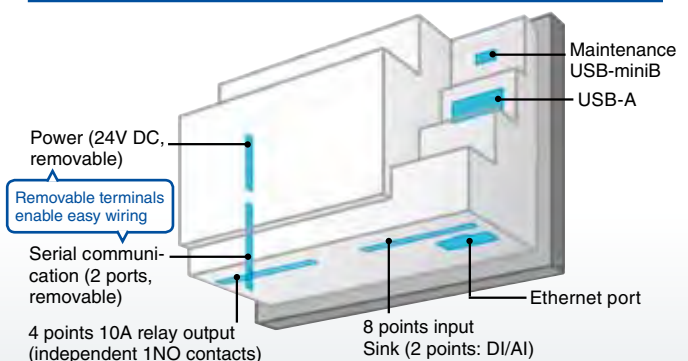



Vertical OK

SmartAXIS

TFT color LCD
3.8 inch
400 cd/m²

STN monochrome LCD
3.7 inch
740 cd/m²

Display Functions

Color LCD 65,536-color high-resolution TFT LCD

Brightest LCD in its class. Compact screen with unparalleled visibility.



Mono-chrome Backlit with pink, red, or white colors

Check the system status easily with the super-bright display with pink, red, or white backlight. Displays the same level of brightness as the color LCD models.

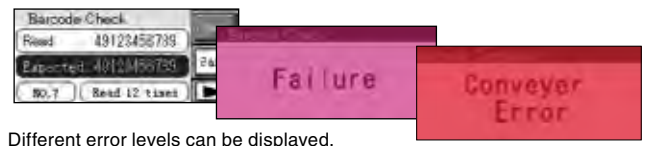

Different error levels can be displayed.

Fast start-up Stress-free, 3-second start-up

Fast start-up allows for easy debugging and stress-free operation.



32-level Brightness Adjustment LED backlight dimming control

The brightness of the backlight can be adjusted according to surrounding conditions (day/night), saving energy.

Rear Mount Adapter Flexible system design with rear mount adapter

An adapter to rear mount the Touch. Choose the most suitable mounting method to mount on the equipment.

(The customer should prepare the panel surface sheet and panel cut-out.)

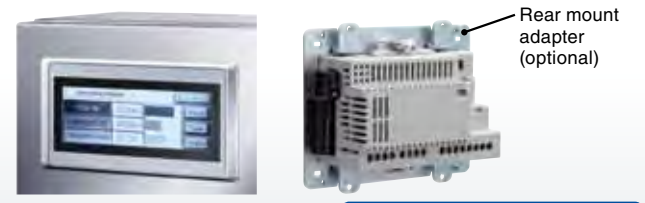

When installed

For other functions see page 8

SmartAXIS Pro/Lite

Control functions x Optimum control

Controls for various applications

Compact, easy-to-use controller. Independent dual axis, high-speed counter, and interrupt input are available. Equipped with an LCD, HMI functions such as messages, monitoring, and parameters can be changed easily. Status monitoring and maintenance is possible to enhance productivity.

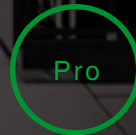

(Photo: when cartridge is used)

Control Functions

Fast Processing Speed

Stable and efficient processing

Basic instructions processing time: 950µs/1000 steps

Memory

Large memory size for easy-to-see screen

Large program memory (12 I/O: 12 KB, 24 I/O and up: 48 KB) achieves reduction of development processes.

High Speed Counter

Positioning control possible with only one controller

Supports positioning control with a single-phase (100 kHz)/4 point or a single-phase (100 kHz)/two-phase (50 kHz)/2 point high-speed counter input. Ideal for easy positioning or motor control using a rotary encoder. Equipped with 6 points for interrupt input, catch input, and frequency input.

10A Relay

No external relay, reducing wiring

10A output relays connect directly to small motors and solenoid valves. No additional circuit necessary to connect a relay, reducing wiring.

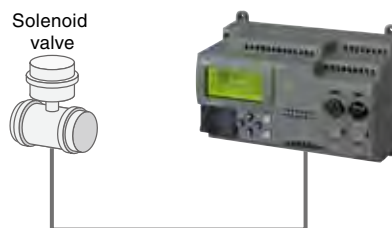

High-speed Output

Built-in biaxial positioning function

Independent dual-axis control is performed using two pulse outputs. Locational values can be easily defined for precise position (trapezoidal) control.

[See page 9](#)



(Photo: when cartridge is used)

Lite

SmartAXIS Lite is a controller without an LCD. Ideal for use in a control panel where there is no need for user operation.



SD Memory Card Easy log data saving

Data can be saved or transferred by using an SD memory card. Saved data can be read via Ethernet. Up to 64 data registers can be saved at the same time. Can store up to 4 data per second (depends on the program processing speed.)

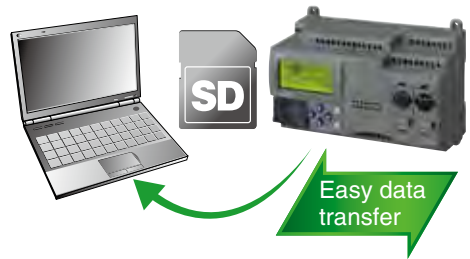

Memory Cartridge Easy maintenance, no PC required.

User programs can be read or written easily, reducing labor. When a memory cartridge is installed in the SmartAXIS, the user program stored in the memory cartridge is executed.

Structure

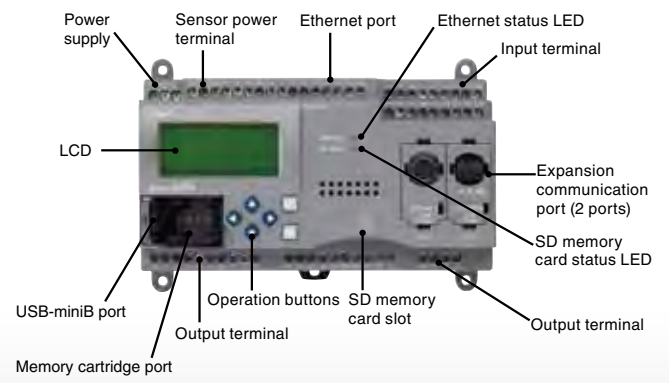

For other functions see page 8 ▶

SmartAXIS Functions

Touch/Pro/Lite Functions

I/O Monitor

"I/O status monitor" screen for monitoring I/O status

The monitor screens on LCD show ON/OFF status of I/Os (Touch/Pro only), enabling quick I/O status monitoring when error occurs.



Ladder Monitor

Easy troubleshooting

Easy ladder program monitoring using 4 buttons. Parameters on monitor screens can be checked and changed easily. (Touch/Pro only)

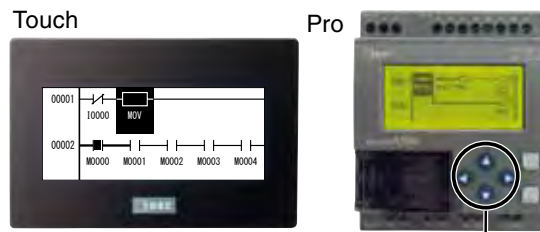

Inputs from the operation buttons can be programmed as digital inputs. No external device necessary for checking the programs.

Clock

Easy time schedule control using "Clock Function"

Clock function enables you to automatically control the time schedule for systems such as lighting or water sprinkler.

Ethernet

Remote maintenance

The user program can be downloaded to/uploaded from the SmartAXIS at remote locations via Ethernet (except 12 I/O type of Pro/Lite).

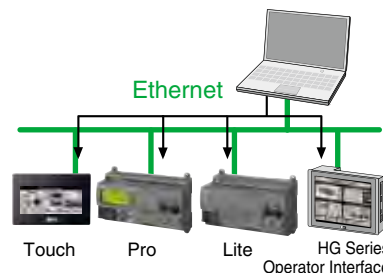

Efficiency

Digital/analog (0 to 10V DC) compatible input

External analog potentiometer makes it easy to set the timer. Suitable for applications requiring a few analog inputs. (Pro/Lite: DC power model only)

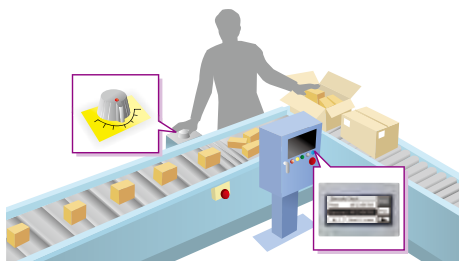

Front Panel Maintenance

Easy data maintenance, shortening setup and adjustment time.

Using a panel mount extension cable, data can be transferred without opening the panel. Debugging of ladder program in the controller is also possible (Touch only).

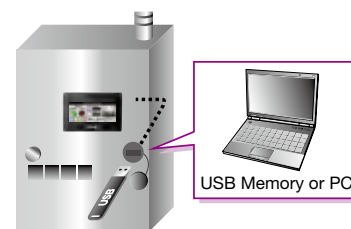

Security

Password protection for secure system operation

Protect systems and programs using a password.



Operator Interface

Connection to Operator Interface

Pro/Lite can be connected to IDEC's HG series operator interface for powerful expressivity and rich information.

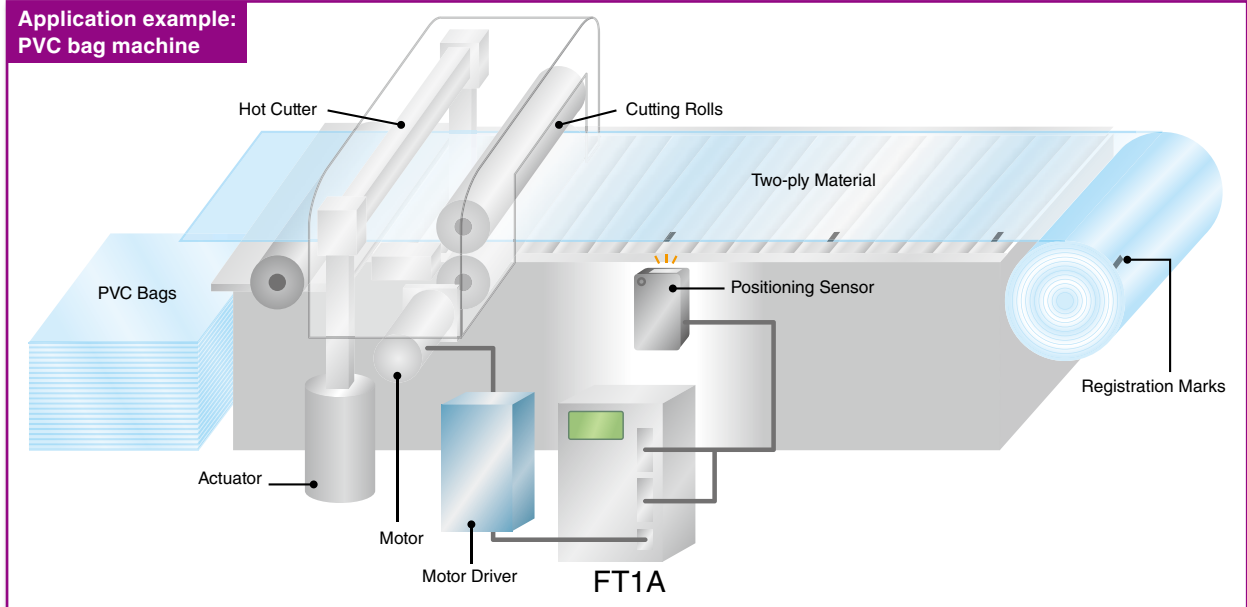

Photo: HG3G Operator Interface

Positioning **Multistage Control**

Independent dual-axis control is possible using two pulse outputs. Positioning (ramp-up/down control) can be achieved easily by setting the required values.

For applicable models, see pages 2 & 3



■ WindLDR: setting screen with preview



■ Target frequency change programmable for 18 steps maximum

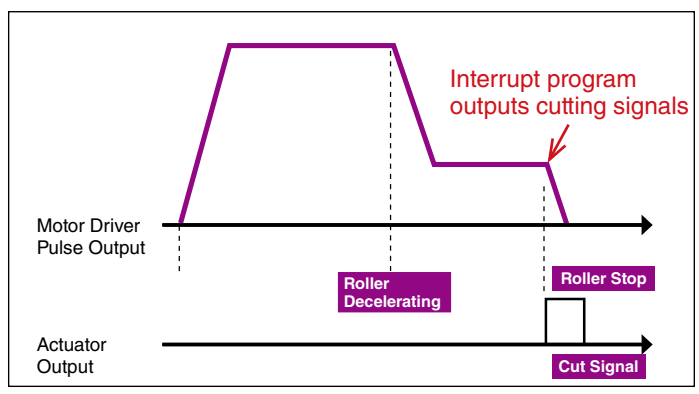

Various Application Examples

Applications	Functions	10A Relay	Analog Input	Calendar	Pulse Output	Data Logging	Ethernet Coommunication	User Communication	USB Communication
Elevator Control		●			●				
Drain Pumps		●	●	●		●	●		
Water Server		●				●		●	
Coffee Server		●	●						
Vending Machine		●	●			●			
Sprinkler		●		●				●	
Mist Generator			●	●					
Greenhouse Control			●	●		●	●		
Coin-operated Shower		●	●			●			
Golf Ball Feeder					●	●			
System Status Collection						●	●		
Barcode Reader						●		●	●
Ethernet Remote I/O (Note)							●		

Note: Available soon

SmartAXIS Programming Software

Automation Organizer WindLDR PLC Programming Software



SmartAXIS Pro/Lite can be programmed using programming software WindLDR Ver. 7.0 or higher. WindLDR has a program editor, cross reference, monitor, simulation, and other functions that are required to use the SmartAXIS. WindLDR programs can also be used on the MicroSmart series PLC, making it possible to utilize existing resources effectively.

1. Calendar



Yearly and weekly schedule can be programmed easily using dialog setting.

2. Log Setting

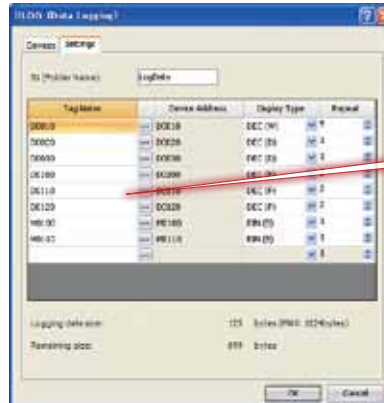

Log data can be configured easily.

Note: Pro/Lite log data are stored in SD memory card.

3. Property Sheet

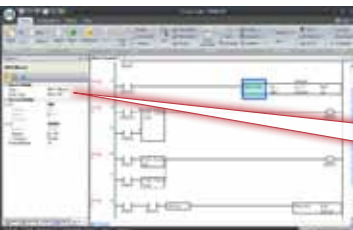

Parameters can be changed without the need to open a dialog box.

4. Simulation



The operation of ladder programs can be confirmed on the WindLDR without connecting a PC to the SmartAXIS.

5. Message Instruction

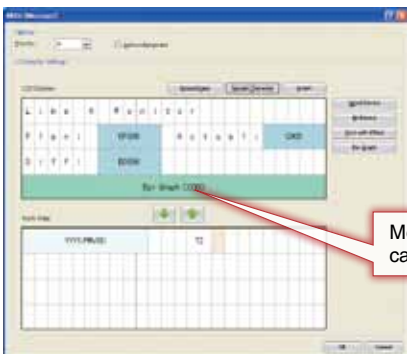

Message on Pro's LCD can be programmed easily.

6. Program Management

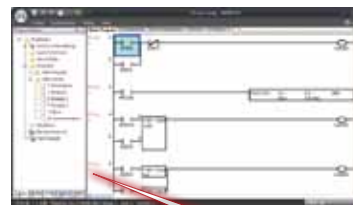

Subroutine function enables creating programs depending on the program function and subject for operation.

- System Requirements**
- OS Windows 7 (32-bit/64-bit), Windows Vista (32-bit), Windows XP (32-bit, Service Pack 3 or later) (Ensure that your operating system has the latest update from the Microsoft Windows Update website)
 - 1.0GHz or faster CPU • Microsoft .NET Framework 3.5 • 1GB RAM • 1GB hard disk space
 - Screen resolution of 1024 × 768 • Mouse, CD-ROM drive, administrator account
 - * IDEC does not guarantee that all operations will function on all personal computers satisfying the above conditions.
 - * Windows is a registered trademark of Microsoft Corporation, USA and other countries.
 - * WindLDR is included in IDEC's package software "Automation Organizer."

Automation Organizer WindO/I-NV3 OITouchscreen Programming Software

WindO/I-NV3 enables programming and also control program editing of the SmartAXIS Touch. Set HMI and control functions in just a few clicks!

1. Ladder program

Download configuration and control programs from WindO/I-NV3.

Start WindLDR easily from WindO/I-NV3. Programs, ladder programs/edits are saved and downloaded as one file, making program management easy.

Double-click to start WindLDR

Note: Simulation is not available with WindO/I-NV3 V5.0.

2. Design screens using the object list

No.	Name	Type	Device	Trigger Type	Trigger Condition
48	Bitmap	Bitmap			
49	NumInput1	Numeric	LDR 002	3 Always ON	
50	MultiCommand1	Multi Co.	LDR 000	0 Rising ed.	[LSM 01]
51	MultiCommand1	Multi Co.	LDR 010	6 While sat.	100 > [LDR 010]
52	NumInput1	Numeric	LDR 1000	3 Always ON	
53	ScreenButton	Goto Scr.	100	3 Always ON	
54	PrintButton1	Print But.	LDR 1000 = 0	3 Always ON	
55	ScreenSwitch3	Goto Scr.	1	3 Always ON	
56	ScreenSwitch3	Goto Scr.	1	3 Always ON	
57	WordCommand1	Word Wi.	LSD 051	3 Always ON	
58	ScreenSwitch3	Goto Scr.	1	3 Always ON	
59	ScreenSwitch3	Goto Scr.	2	3 Always ON	
60	ScriptCommand1	Script Co.	5	7 Fixed	

Device, operating conditions, and type of command can be read from the object list. During debugging, data stored in the device is shown in popups, and operating conditions can be distinguished via color.

3. Graphic library with extensive collection of images

Vivid and clear 7000 graphic images can be selected from the library tool.

4. Easy programming

Operating conditions for buttons and lamps can be programmed easily in the property settings. Ladder program and scripting are also available.

5. Create multi-language screens easily

Switch to any of the supported languages by using the text manager within the same project. Up to 16 different languages can be programmed for one project. Translation is easy as Unicode format files can be imported/exported.

ID	Font	Color	Message
1	Windows	255	STOP
2	Windows	000	START
3	Windows	028	MENU
4	Windows	000	Running

6. Central control of device addresses

Device addresses used in the project can be easily identified by using the tag name editor and cross-references. Changes in tag name editor is reflected to the ladder, lamp, and switch.

Address	Tag Name	Comment
M0000	Start	Main Pow
M0001	Stop	Main Pow
M0002	Switch01	Input01
M0003	Switch02	Input02

Various Networks for a Wide Variety of Applications

(Except for 12 I/O type of Pro/Lite)

User Communication

The user communication of the SmartAXIS enables you to control external devices such as PCs, printers, and barcode readers.

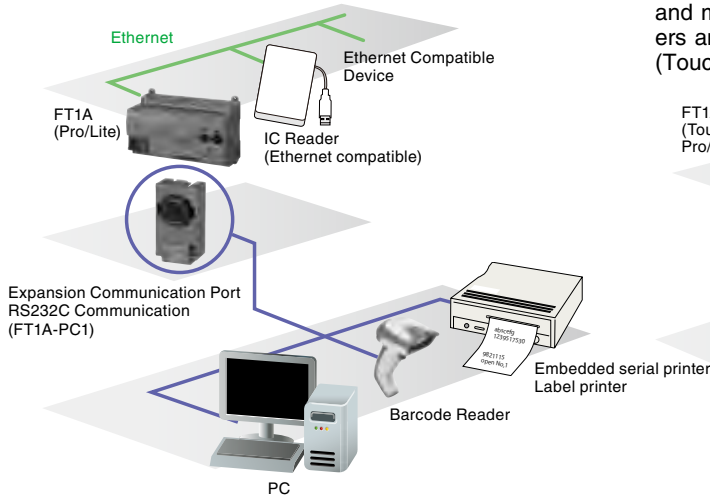

Modbus RTU Communication

The SmartAXIS is compliant with Modbus protocol and can be used as either a Modbus communication master or slave. When used as a Modbus master, the SmartAXIS can monitor and modify data of Modbus compliant devices such as inverters and temperature controllers using Modbus communication (Touch can be used as a master only).

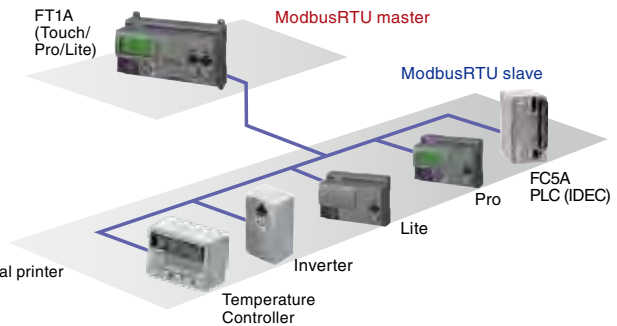

Modbus TCP

The SmartAXIS supports Modbus communications protocols. Modbus TCP protocol can also be used on the built-in Ethernet port, and can be used as a client (master) or server (slave), to monitor and change data of devices such as inverters and temperature controllers.

Note: When Pro/Lite is the client (master): up to 3 servers (slaves) can be connected.
When Touch is the client (master): up to 16 servers (slaves) can be connected.

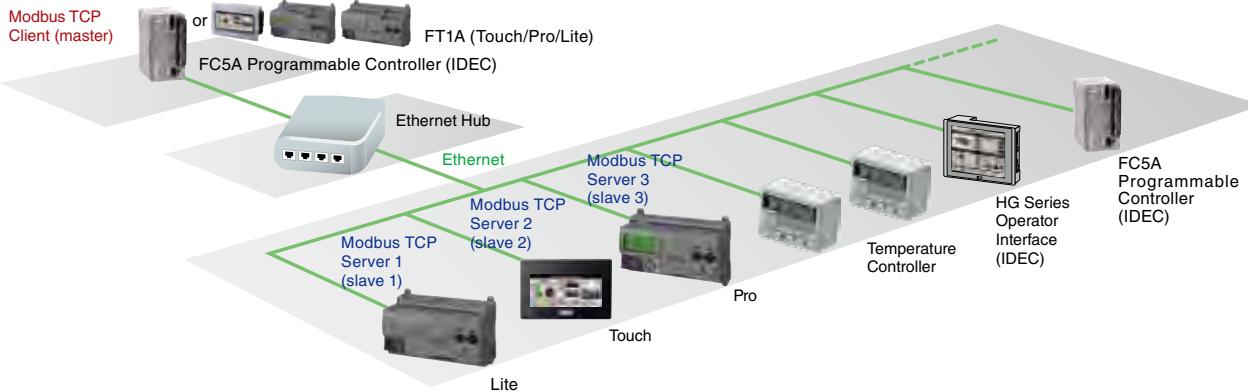

Remote I/O

The remote I/O of the SmartAXIS enables you to expand the number of inputs and outputs by connecting separate SmartAXIS modules over Ethernet as remote I/O slaves. The total number of I/Os can be expanded up to 144 I/Os. The SmartAXIS remote I/O master can use the analog inputs on the remote I/O slaves (Pro/Lite only). (Available soon)

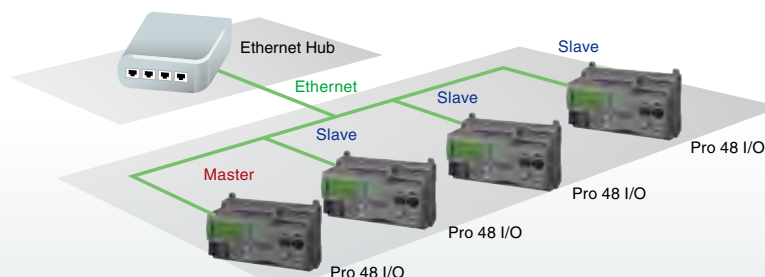

SmartAXIS Series FT1A Controller

Powerful PLC with embedded I/O.

Touch, Pro, and Lite models for flexible use in almost all applications.

- Digital/analog-compatible input available for 24V DC. Convenient for systems requiring minimal analog inputs.
- 10A output relays connect directly to small motors and solenoid valves.
- Supports communication via RS232C, RS485, and Ethernet.
- USB programming port.
- User's program can be changed with the memory cartridge (Pro/Lite) or USB memory (Touch).

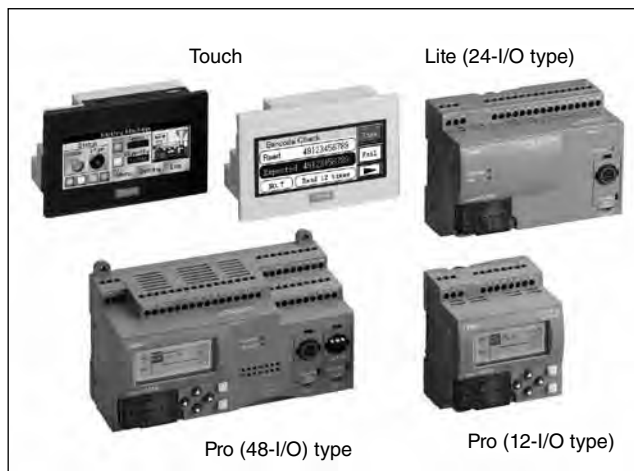

Touch (Display model)

- By integrating the control function (same functionality as Lite 12-I/O type) with a small display, a connected device is not needed. Wire and space-saving features offer the ideal solution for cost- and time-savings.
- Touch is an advanced small display with integrated control function.
- 400cd/m² high-contrast and 65,536 color high-resolution TFT LCD provides unparalleled visibility.
- Adjustable LED brightness function.
- Monochrome STN models are equipped with a 740 cd/m² brightness LCD and backlit with a choice of 3 colors (pink, red, white), providing practically the same brightness as the color LCD models.
- Program both the Pro and Lite models using WindLDR and the Touch model using WindO/I-INV3. Our intuitive programming software that is easy even for the first-time users.



Touch (dark gray)
(photo: FT1A-*12RA-B)



Touch (light gray)
(photo: FT1A-*12RA-W)

Pro (LCD Model) / Lite (No LCD Model)

- Parameters such as counters and timers can be adjusted using the LCD and six operations buttons (also available on Touch).
- Monitor screens on LCD show system status and settings.
 - “I/O status monitor” screen for monitoring I/O status
 - “Device monitor” screen for monitoring SmartAXIS device values
 - “Ladder Monitor” screen for monitoring the operating ladder program
 - “Status monitor” screen: also useful for confirming protection status and scan time
 The states of four operation buttons can be used as digital inputs in the user programs.
- Supports positioning control with a single-phase (100 kHz)/4 point or a single-phase (100 kHz)/two-phase (50 kHz)/2 point high-speed counter input and 100 kHz/2 point pulse output. The new ARAMP instruction and enables you to program complex positioning systems easily.
- Integrated data logging function using an SD memory card. Logged data is useful for system maintenance management. (Touch: available using USB memory)
- Lite (No LCD) is available, offering more options for product selection.



Pro
(photo: FT1A-H48KC when using communication cartridge)



Lite
(photo: FT1A-B24RA when using communication cartridge)

SmartAXIS Series FT1A Controller

FT1A

Touch (Display Models)

Package Quantity: 1

Power	I/O	Input		Output	Program Size	Interfaces	LCD	Bezel Color	Part No.	
		Digital I/O	Analog I/O (Note 1)							
24V DC	12 points (8/4)	6	2	4 points 10A relay output	5 MB (Including 48 KB control data)	USB-A USB-mini B RS232C RS422/485 Ethernet	STN monochrome	Light gray	FT1A-M12RA-W	
								Dark gray	FT1A-M12RA-B	
								Silver	FT1A-M12RA-S	
								TFT color	Light gray	FT1A-C12RA-W
									Dark gray	FT1A-C12RA-B
Silver	FT1A-C12RA-S									

Pro (LCD Models)

Package Quantity: 1

Power	I/O	Input		Output	High-Speed Tr. Output	Program Size	Interfaces					SD Memory Card	Part No.										
		Digital I/O	Analog I/O (Note 1)				USB mini-B Port	Ethernet Port	Expansion communication port (Note 2)		Memory Cartridge												
24V DC	12 points (8/4)	24V DC Input	6	2	4 points 10A relay output	12 KB	×	—	—	—	—	—	—	FT1A-H12RA									
	24 points (16/8)		12	4	4 points 10A relay output 4 points 2A relay output									FT1A-H24RA									
	40 points (24/16)		18	6	4 points 10A relay output 8 points 2A relay output	4 points Tr sink output								48 KB	×	×	×	×	×	×	×	FT1A-H40RKA	
						4 points Tr source output																FT1A-H40RSA	
	48 points (30/18)		22	8	18 points Tr sink output 18 points Tr source output	×								48 KB	×	×	×	×	×	×	×	FT1A-H48KA	
						×																FT1A-H48SA	
100 to 240V AC	12 points (8/4)	24V DC Input	8	—	4 points 10A relay output	12 KB	×	—	—	—	—	—	—	FT1A-H12RC									
	24 points (16/8)		16		4 points 10A relay output 4 points 2A relay output									FT1A-H24RC									
	40 points (24/16)		24		—	4 points 10A relay output 12 points 2A relay output								—	48 KB	×	×	×	×	×	×	×	FT1A-H40RC
														×									FT1A-H48KC
	48 points (30/18)		30		—	18 points Tr sink output 18 points Tr source output								×	48 KB	×	×	×	×	×	×	×	FT1A-H48SC
														×									FT1A-H48SC

Lite (No LCD Models)

Package Quantity: 1

Power	I/O	Input		Output	High-Speed Tr. Output	Program Size	Interfaces					SD Memory Card	Part No.										
		Digital I/O	Analog I/O (Note 1)				USB mini-B Port	Ethernet Port	Expansion communication port (Note 2)		Memory Cartridge												
24V DC	12 points (8/4)	24V DC Input	6	2	4 points 10A relay output	12 KB	×	—	—	—	—	—	—	FT1A-B12RA									
	24 points (16/8)		12	4	4 points 10A relay output 4 points 2A relay output									FT1A-B24RA									
	40 points (24/16)		18	6	4 points 10A relay output 8 points 2A relay output	4 points Tr sink output								48 KB	×	×	×	×	×	×	×	FT1A-B40RKA	
						4 points Tr source output																FT1A-B40RSA	
	48 points (30/18)		22	8	18 points Tr sink output 18 points Tr source output	×								48 KB	×	×	×	×	×	×	×	FT1A-B48KA	
						×																FT1A-B48SA	
100 to 240V AC	12 points (8/4)	24V DC Input	8	—	4 points 10A relay output	12 KB	×	—	—	—	—	—	—	FT1A-B12RC									
	24 points (16/8)		16		4 points 10A relay output 4 points 2A relay output									FT1A-B24RC									
	40 points (24/16)		24		—	4 points 10A relay output 12 points 2A relay output								—	48 KB	×	×	×	×	×	×	×	FT1A-B40RC
														×									FT1A-B48KC
	48 points (30/18)		30		—	18 points Tr sink output 18 points Tr source output								×	48 KB	×	×	×	×	×	×	×	FT1A-B48SC
														×									FT1A-B48SC



Note 1: Digital/analog-compatible input

Note 2: The following communication cartridges can be connected.

FT1A-PC1: RS232C, mini-DIN type, FT1A-PC2: RS485, mini-DIN type, FT1A-PC3: RS485, terminal block type

Options / Maintenance Parts

Options

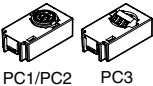
Name/Appearance	Applicable Model			Part No. (Ordering No.)	Package Quantity	Specifications
	Touch	Pro	Lite			
Application software	×	×	×	SW1A-W1C	1	Automation Organizer Ver. 2.0 or higher (Note 1)
USB maintenance cable 	×	×	×	HG9Z-XCM42	1	USB cable (length 2 m), USB-miniB
Panel mount extension cable	×	—	—	HG9Z-XCE11	1	USB-A port extension cable (length 1 m)
	×	×	×	HG9Z-XCE21	1	USB-mini B port extension cable (length 1 m)
Screen protection sheet (Note 2)	×	—	—	FT9Z-1D3PN05	5	
Protective cover	×	—	—	FT9Z-1E3PN05	5	
Memory card 	— (Note 3)	×	×	HG9Z-XMS2	1	SD memory card (2 GB)
Memory cartridge 	—	×	×	FT1A-PM1	1	Dedicated user program save memory (1 MB)
Communication cartridge 	—	×	×	FT1A-PC1	1	RS232C, mini-DIN type
	—	×	×	FT1A-PC2	1	RS485, mini-DIN type
	—	×	×	FT1A-PC3	1	RS485, terminal block type
Rear mount adapter	×	—	—	FT9Z-1A01	1	Rear mount bracket
35-mm-wide DIN Rail	—	×	×	BAA1000PN10	10	Aluminum, 1000mm long, 200g (approx.)
	—	×	×	BAP1000PN10	10	Steel, 1000mm long, 200g (approx.)
DIN rail mounting bracket	—	×	×	BNL6PN10	10	DIN rail bracket
Touch User's Manual	Japanese	×	—	FT9Y-B1389	1	
	English	×	—	FT9Y-B1390	1	
Pro/Lite User's Manual	Japanese	—	×	FT9Y-B1377	1	
	English	—	×	FT9Y-B1378	1	
SmartAXIS Ladder Programming Manual	Japanese	×	×	FT9Y-B1381	1	
	English	×	×	FT9Y-B1382	1	

Note 1: Upgrade from earlier version is possible on IDEC website. The following manuals in PDF can be downloaded from IDEC website.

FT1A SmartAXIS Touch User's Manual (English, Japanese, Simplified Chinese)

FT1A SmartAXIS Pro/Lite User's Manual (English, German, Japanese, Simplified Chinese)

FT1A SmartAXIS Ladder Programming Manual (English, German, Japanese, Simplified Chinese)





Note 2: UV resistance material is used. However, resistance against direct sunlight in outdoor usage is not guaranteed.

Note 3: Use commercially-available USB memory to store project data, log data, and recipe file of Touch models.

Note 4: Can be used for 40-I/O and 48-I/O types. Note that user programs cannot be stored or read using an SD memory card. If necessary, use a memory cartridge.

Note 5: Cannot be used for expansion with 12-I/O type.

Maintenance Parts

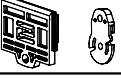
Name	Applicable Model			Part No. (Ordering No.)	Package Quantity	Specification
	Touch	Pro	Lite			
Communication Interface plug 	×	—	—	FT9Z-1T09	1	For communication ports (black)
Power supply plug 	×	—	—	FT9Z-1X03	1	For power supply terminals (black)
Mounting bracket 	×	—	—	HG9Z-4K2PN04	4	
USB cable lock pin 	×	—	—	HG9Z-XU1PN05	5	Used when using the USB cable on a regular basis
Direct mounting hook 	—	×	×	FT9Z-PSP1PN05	5	Direct mounting hook for Pro/Lite

General Specifications

Touch (Display Model)

Part No.	FT1A-*12RA-*
Rated Power Voltage	24V DC
Allowable Voltage Range	20.4 to 28.8V DC (including ripple)
Power Consumption	9.2W maximum
Allowable Momentary Power Interruption	10 ms maximum
Dielectric Strength	1. Between power terminal and FG: 500V AC, 5 mA, 1 minute 2. Between power terminal and output terminal: 2,300V AC, 5 mA, 1 minute
EMC Immunity	IEC/EN 61131-2:2007 compliant
Inrush Current	50A maximum (5ms maximum)
Operating Temperature	0 to +50°C
Storage Temperature	-20 to +60°C (no freezing)
Relative Humidity	10 to 95% RH (no condensation)
Pollution Degree	2 (IEC 60664-1)
Corrosion Immunity	Atmosphere free from corrosive gases
Degree of Protection	IP66F (Panel front) (Note 1) IP20 (Rear)
Ground	Functional grounding
Protective grounding conductor	AWG16
Vibration Resistance	5 to 8.4 Hz half amplitude 3.5 mm, 8.4 to 150 Hz, Acceleration 9.8 m/s ² (1G) 2 hours per axis on each of three mutually perpendicular axis (IEC 61131-2)
Shock Resistance	147 m/s ² , 11 ms, X, Y, Z directions 3 times (IEC 61131-2)
Mounting Structure	Panel mount
Weight (approx.)	300g

Note 1: Operation not guaranteed when used with certain types of oils.

Pro/Lite (LCD Model/No LCD Model)

Part No.	Pro/Lite									
	12-I/O Type H12RC H12RA B12RC B12RA		24-I/O Type H24RC H24RA B24RC B24RA		40-I/O Type H40RC H40RKA H40RSA B40RC B40RKA B40RSA			48-I/O Type H48KC H48SC H48KA H48SA B48KC B48SC B48KA B48SA		
Rated Power Voltage	AC power: 100 to 240V AC DC power: 24V DC									
Allowable Voltage Range	AC power: 85 to 264V AC DC power: 20.4 to 28.8V DC (including ripple)									
Rated Power Frequency	AC power: 50 to 60 Hz (47 to 63 Hz)									
Power Consumption	AC power	12-I/O: 18 VA maximum, 24-I/O: 41 VA maximum, 40-I/O: 48VA maximum, 48-I/O: 43 VA maximum								
	DC power	12-I/O: 4.3W maximum, 24-I/O: 4.8W maximum, 40-I/O: 7.9W maximum, 48-I/O: 6.0W maximum								
Allowable Momentary Power Interruption	AC power: 20 ms maximum DC power: 10 ms maximum									
Dielectric Strength	AC power type: Between power/input and PE terminals: 1,500V AC, 1 minute Between transistor output and PE terminals: 1,500V AC, 1 minute Between relay output and PE terminals: 2,300V AC, 1 minute Between power and input terminals: 1,500V AC, 1 minute Between power/input and transistor output terminals: 1,500V AC, 1 minute Between power/input and relay output terminals: 2,300V AC, 1 minute DC power type: Between power/input and FE terminals: 500V AC, 1 minute Between transistor output and FE terminals: 500V AC, 1 minute Between relay output and FE terminals: 2,300V AC, 1 minute Between power/input and transistor output terminals: 500V AC, 1 minute Between power/input and relay output terminals: 2,300V AC, 1 minute									
EMC Immunity	IEC/EN 61131-2:2007 compliant									
Inrush Current	AC power: 35A maximum (Cold start with Ta=25°C, 200V AC) DC power: 30A maximum (5ms maximum)									
Operating Temperature	0 to +55°C (Note)									
Storage Temperature	-25 to +70°C (no freezing)									
Relative Humidity	10 to 95% RH (no condensation)									
Pollution Degree	2 (IEC 60664-1)									
Corrosion Immunity	Atmosphere free from corrosive gases									
Degree of Protection	IP20 (IEC 60529)									
Ground	D-type ground (Class 3 ground)									
Protective grounding conductor	UL1007 AWG16									
Vibration Resistance	5 to 8.4 Hz half amplitude 3.5 mm, 8.4 to 150 Hz, Acceleration 9.8 m/s ² (1G) 2 hours per axis on each of three mutually perpendicular axis (IEC 61131-2)									
Shock Resistance	147 m/s ² , 11 ms, X, Y, Z directions 3 times (IEC 61131-2)									
Mounting Structure	DIN rail or direct mount									
Weight (approx.)	AC power	12-I/O: 230g, 24-I/O: 400g, 40-I/O: 580g, 48-I/O: 540g								
	DC power	12-I/O: 190g, 24-I/O: 310g, 40-I/O: 420g, 48-I/O: 380g								

Note: UL, c-UL Listed at 0 to +50°C (FT1A Version V110)

Function Specifications (Touch/Pro/Lite)

Part No.		Touch			Pro/Lite FT1A-															
		FT1A-12RA-*	H12RA B12RA	H12RC B12RC	H24RA B24RA	H24RC B24RC	H40RKA H40RSA B40RKA B40RSA	H40RC B40RC	H48KA H48SA B48KA B48SA	H48KC H48SC B48KC B48SC										
Control System		Stored program system																		
Instruction Words	Basic Instructions	42 types																		
	Advanced Instructions	97 types	99 types		107 types		DC power type: 125 types, AC power type: 111 types													
Program Capacity		Program size: 48 KB Configuration memory capacity: 5 MB		12 KB		48 KB														
User Program Storage		Flash ROM (100,000 times)			Built-in Flash ROM (10,000 times rewritable)															
Processing Time	Basic Instruction	1850µs/1000 steps		950 µs/1000 steps																
	END Processing	5 msec minimum		2 ms (Pro) / 640 µs (Lite)																
I/O Points	Inputs	8	8	16		24		30												
	Outputs	4	4	8		16		18												
Internal Relays		1024		256		1024														
Shift Registers		128		128		128														
Data Registers		2000		400		2000														
Special Data Registers		200		200		200														
Adding/Reversible Counters		200		100		200														
Timer (1ms, 10 ms, 100 ms, 1s)		200		100		200														
Clock		Precision: ±30 seconds/month (25°C, typical)																		
RAM Backup	Backup Data	Internal relays, shift registers, counters, data registers, clock data																		
	Backup Duration	Approximately 30 days (typical) at 25°C after backup battery is fully charged																		
	Battery	Lithium secondary battery																		
	Charging Time	Approximately 15 hours required to charge from 0 to 90%																		
	Replaceability	Not possible																		
Self-Diagnostic Functions		Keep data check, power failure check, clock error check, watchdog timer check, timer/counter preset value change error check, user program syntax check, user program execution check, system error check, memory cartridge transfer error check (Pro/Lite only)																		
Input Filter		No filter, 3 to 15 ms (selectable in increments of 1 ms)																		
Catch Input/Interrupt Input		4/4		4/4		6/6														
High-speed Counter	Maximum Counting Frequency and Points	Single/two-phase selectable	1 (5 kHz, multiple 2/4, single-phase cannot be used)		2 (100 kHz when single-phase, 50 kHz when two-phase, multiple 2.4)		—		2 (100 kHz when single-phase, 50 kHz when two-phase, multiple 2.4)		2 (100 kHz when single-phase, 50 kHz when two-phase, multiple 2.4)		—							
		Single-phase	4 (x 10 kHz)		2 (x 100 kHz)		—		4 (x 100 kHz)		—		4 (x 100 kHz)							
	Counting Range	0 to 4,294,967,295 (32 bits)																		
	Operation Mode	Rotary encoder mode and adding counter mode																		
Analog Voltage Inputs	Points	2		2		None		4		None		6		None		8		None		
	Input Range	0 to 10V DC																		
	Input Impedance	78 kΩ																		
	Digital Resolution	10-bit (0 to 1000)																		
Pulse Outputs	100 kHz	No. of outputs	—		—		—		—		—		2		—		2		2	
		Function	—		—		—		—		—		PULS, PWM, RAMP, ARAMP, ZRN		—		PULS, PWM, RAMP, ARAMP, ZRN		—	
	5 kHz	No. of outputs	—		—		—		—		—		2		—		2		2	
		Function	—		—		—		—		—		PULS, PWM		—		PULS, PWM		—	
External Output Power Supply for Sensor	Output Voltage	—		—		—		—		24V DC (+10%, -15%)		—		24V DC (+10%, -15%)		—		24V DC (+10%, -15%)		
	Output Current	—		—		—		—		250 mA		—		300 mA		—		300 mA		
	Overload Detection	—		—		—		—		Impossible		—		Impossible		—		Impossible		
	Insulation	—		—		—		—		Internal Circuit		—		Internal Circuit		—		Internal Circuit		
USB-mini B		×		×		×		×		×		×		×		×		×		
USB-A		×		—		—		—		—		×		—		—		—		
RS232C		×		—		—		× (Note 1)		×		× (Note 1)		×		×		× (Note 1)		
RS485/422		×		—		—		× (Note 1)		×		× (Note 1)		×		×		× (Note 1)		
Ethernet		×		—		—		×		×		×		×		×		×		
Expansion Communication Ports	Port 2	—		—		—		×		×		×		×		×		×		
	Port 3	—		—		—		—		—		×		×		×		×		
Memory Cartridge		—		×		—		×		×		×		×		×		×		
SD Memory Card		—		—		—		—		—		×		×		×		×		

Note 1: When communication cartridge is installed. Note 2: The maximum capacity is 32 GB. DLOG and TRACE instructions are used to write data.

Display Specifications

Touch/Pro (Display Model/Built-in LCD)

Part No.	Touch		Pro
Display Element	TFT color LCD	STN monochrome LCD	STN monochrome LCD
Colors/Shades	65,536 colors	Monochrome 8 shades	Monochrome
Effective Display Area	88.92 W x 37.05 H mm	87.59 W x 35.49 H mm	47.98 W x 18.22 H mm
Display Resolution	240 W x 100 H pixels		192 W x 64 H pixels
View Angle	Left/right 40°, top 20°, bottom 60°	Left/right/top/bottom: 45°	Left/right 30°, top 20°, bottom 40°
Contrast Adjustment	Not possible	32 levels	Not possible
Backlight	LED	LED (white, red, pink)	LED (green)
Backlight Life	50,000 hours (Note 1)		—
Brightness	400 cd/m ² (Note 2)	740 cd/m ² (Note 2)	45 cd/m ²
Brightness Adjustment	32 levels		Not possible
Backlight Control	Auto off function		On/off
Backlight Replacement	Not possible		
Display Character Size	1/4 Size	8 x 8 pixels [Japanese Katakana, JIS 8-bit code, ISO 8859-1 (Latin 1), ANSI 1250 (central Europe)], ANSI 1257 (Baltic), ANSI 1251 (Cyrillic)	
	1/2 Size	8 x 16 pixels [Japanese Katakana, JIS 8-bit code, ISO 8859-1 (Latin 1), ANSI 1250 (central Europe)], ANSI 1257 (Baltic), ANSI 1251 (Cyrillic)	
		16 x 32 pixels, 24 x 48 pixels, 32 x 64 pixels (Western European languages: ISO 8859-1)	
	Full Size	16 x 16 pixels (Japanese JIS first and second level characters, simplified Chinese, traditional Chinese, Korean)	
Double Size	32 x 32 pixels (Japanese JIS first level characters, Mincho font)		
No. of Characters	1/4 Size	30 characters x 12 lines/screen	
	1/2 Size	30 characters x 6 lines/screen	
	Full Size	15 characters x 6 lines/screen	
	Double Size	7 characters x 3 lines/screen	
Character Magnification	0.5x, 1x, 2x, 3x, 4x, 8x vertically and horizontally		—
Character Attributes	Blink, reverse, bold, shadowed (blink is 1 sec or 0.5 sec)		Blink, reverse
Graphics	Line, polyline, polygon, rectangle, circle, ellipse, arc, pie, equilateral polygons (3, 4, 5, 6, 8), fill, picture		—
Window Display	3 popup screens + 1 system screen		—

Note 1: The backlight life refers to the time until the brightness reduces by half after use at 25°C.

Note 2: Brightness of LCD only (monochrome LCD: when lit white).

Operation Specifications

Touch/Pro (Display/LCD Models)

Part No.	Touch	Pro
Switching Element	Analog resistive membrane (touch panel)	Rubber switches
Operating Force	0.2 to 2.5N	2.0 N minimum
Mechanical Life	1 million operations	10,000 operations
Acknowledgment Sound	Electric Buzzer	Not provided
Multiple Press	Not possible	Possible

Input Specifications (Touch/Pro/Lite)

Part No.		Touch		Pro/Lite FT1A-										
		FT1A-*12RA-*	H12RC B12RC	H12RA B12RA	H24RC B24RC	H24RA B24RA	H40RC B40RC	H40RKA B40RKA	H40RSA B40RSA	H48KC B48KC	H48SC B48SC	H48KA B48KA	H48SA B48SA	
Input Specification	Input Points	6 (digital input)	8	6	16	12	24	18	30		22			
	Input Type	Sink	No-voltage (with contact)	Sink	Sink/Source	Sink	Sink/Source	Source	Sink	Sink/Source		Source	Sink	
	Input Voltage Range	0 to 28.8V DC												
	Rated Input Current	4.4 mA	No-voltage type and sink/source type: 5.3 mA, sink type: 4.4 mA, source type: 5.2 mA											
	Input Impedance	5.5 kΩ	No-voltage type and sink/source type: 4.3 kΩ, sink type: 5.5 kΩ, source type: 4.7 kΩ											
	Input Delay Time	OFF → ON	2.5 μs + soft filter setting		40 μs + filter value (high-speed input section: 2.5 μs + filter value)									
		ON → OFF	5 μs + soft filter setting		150 μs + filter value (high-speed input section: 5 μs + filter value)									
	Isolation	Between input terminals	Not isolated		Not isolated									
		Internal circuit	Not isolated		Contact type and sink/source type: photocoupler isolated, sink type and source type: not isolated									
	Input Type	Type 1 (IEC 61131-2)												
	External Load for I/O Interconnection	Not needed												
	Operating Level	OFF voltage	Less than 5 VDC	No-voltage type: 18 kΩ min., sink/source type and sink type: less than 5 VDC, source type: 15 VDC min.										
		ON voltage	15 VDC min.	No-voltage type: 2 kΩ max., sink/source type and sink type: 15 VDC min., source type: less than 5 VDC										
		OFF current	Less than 0.9 mA	No-voltage type and sink/source type: less than 1.1 mA, sink type: less than 0.9 mA, source type: -1.0 mA min.										
		ON current	2.7 mA minimum	No-voltage type and sink/source type: 3.0 mA min., sink type: 2.7 mA min., source type: less than -3.0 mA										
	Analog Input	Input Points	2		2		4		6				8	
		Input Type	Voltage input		Voltage input		Voltage input		Voltage input				Voltage input	
		Input Range	0 to 10.0 VDC		0 to 10.0V DC		0 to 10.0V DC		0 to 10.0V DC				0 to 10.0V DC	
		Sampling Duration Time	2 ms maximum		2 ms maximum		2 ms maximum		2 ms maximum				2 ms maximum	
		Total Input System Transfer Time	2 ms + sampling time + scan time		2 ms + filtering time + scan time		2 ms + filtering time + scan time		2 ms + filtering time + scan time				2 ms + filtering time + scan time	
Resolution		10-bit (0 to 1000)	—	10-bit (0 to 1,000)	—	10-bit (0 to 1,000)	—	10-bit (0 to 1,000)	—	—	—	10-bit (0 to 1,000)		
Input Error		25°C	±3% of full scale		±1.5% of full scale		±1.5% of full scale		±1.5% of full scale				±1.5% of full scale	
		Total	±5% of full scale		±5% of full scale		±5% of full scale		±5% of full scale				±5% of full scale	
Isolation		Between input terminals	Not isolated		Not isolated		Not isolated		Not isolated		Not isolated		Not isolated	
		Internal circuit	Not isolated		Not isolated		Not isolated		Not isolated		Not isolated		Not isolated	
When used as digital input	Digital I/O	— (not conforming to IEC 61131-2 digital I/O type)												
	Operation Level	OFF voltage: 5V maximum												
		ON voltage: 15V minimum												
		OFF current: 0.06mA maximum												
ON current: 0.20mA minimum														
External Power for Input	Input Voltage Range	—	—	—	20.4 to 26.4V DC	—	20.4 to 26.4V DC	—	—	20.4 to 26.4V DC		—	—	
	Output Current Capacity	—	—	—	250 mA	—	300 mA	—	—	300 mA		—	—	

Output Specifications (Touch/Pro/Lite)

Part No.			Touch	Pro/Lite												
			FT1A-*12RA-*	H12RC B12RC	H12RA B12RA	H24RC B24RC	H24RA B24RA	H40RC B40RC	H40RKA B40RKA	H40RSA B40RSA	H48KC B48KC	H48SC B48SC	H48KA B48KA	H48SA B48SA		
Output Specification	Output Points	Transistor Sink Output							4	—	18	—	18	—		
		Transistor Source Output							—	4	—	18	—	18		
	Rated Load Voltage		24V DC													
	Input Voltage Range		20.4 to 28.8V DC													
	Maximum Load Current	1 point	0.3A maximum													
	Load Current	1 common	1A maximum													
	Voltage Drop (ON Voltage)		1V maximum (voltage between COM and output terminals when output is ON)													
	Inrush Current		1A													
	Leakage Current		0.1 mA maximum													
	Clamping Voltage		39V ± 1V													
	Maximum Lamp Load		—	—	—	—	—	—	—	8 W maximum						
	Inductive Load		L/R = 10 ms (28.8V DC, 1 Hz)													
	External Current Draw		100 mA maximum, 24V DC (V terminal supply power)													
	Isolation	Between output terminal and internal circuit	Photocoupler isolated													
Between output terminals		Same common line: Not isolated Separate common line: isolated														
Output Delay	OFF → ON	High-speed output terminal (100 kHz pulse output terminal): 5 μs max. Normal output terminal (including 5kHz pulse output terminal): 100 μs max.														
	ON → OFF	High-speed output terminal (100 kHz pulse output terminal): 5 μs max. Normal output terminal (including 5kHz pulse output terminal): 100 μs max.														
10A relay	Output Points		4													
	Output Type		1a contact													
	Rated Load Current		240V AC 10A, 24V DC 10A													
	Minimum Switching Load		10 mA/5V DC (reference value)													
	Initial Contact Resistance		100 mΩ maximum (1A, at 6V DC)													
2A relay	Output Points					4	4	12	8	8						
	Output Points per Common Line	COM4				4	4	4	4	4						
		COM5				—	—	4	4	4						
		COM6				—	—	4	—	—						
	Output Type		—	—	—	1a contact										
	Maximum Load Current	1 point	2A													
Load Current	1 common	8A maximum														
Minimum Switching Load		1 mA/5 VDC (reference value)														
Initial Contact Resistance		30 mΩ maximum (1A, at 6V DC)														
Relay Output Common	Electrical Life		100,000 operations minimum (resistive load 1,800 operations/h)													
	Mechanical Life		20 million operations minimum (no load 18,000 operations/h)													
	Dielectric Strength	Between output terminal and internal circuit	2,300V AC, 1 minute													
		Between output terminals (between COMs)	2,300V AC, 1 minute													

Dimensions

Touch (Display Model)

When using mounting bracket (HG9Z-4K2PN04)

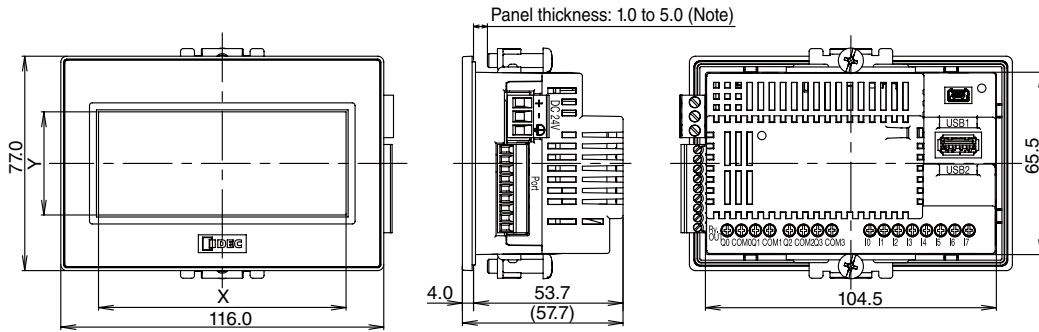

Note: Waterproof characteristic may not be obtained depending on the panel material and size.

LCD Active Area

LCD Type	X	Y
TFT	88.92	37.05
STN	87.59	35.49

When using rear mount adapter (FT9Z-1A01)

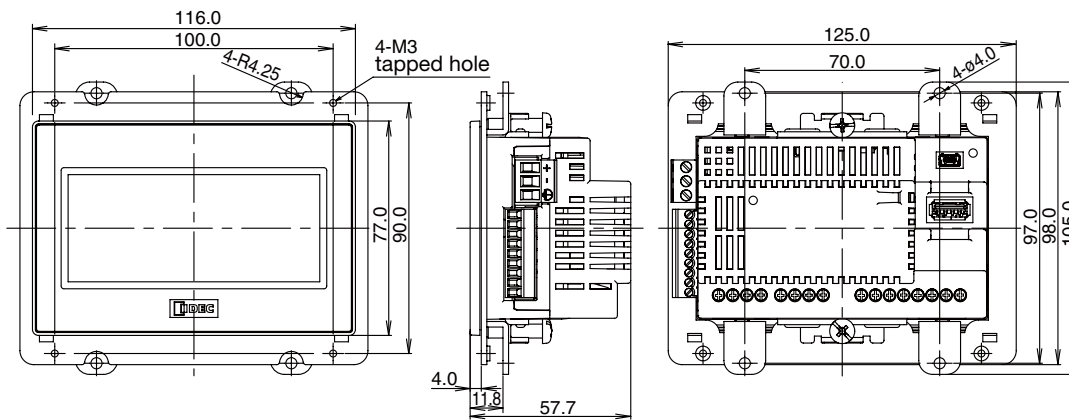

Pro (LCD Model)

FT1A-H12*A/*C

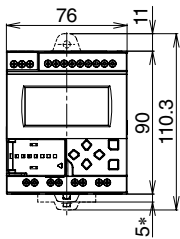

FT1A-H24*A/*C

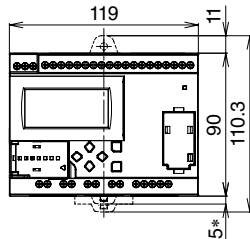

Lite (No LCD Model)

FT1A-B12*A/*C

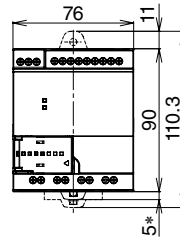

FT1A-B24*A/*C

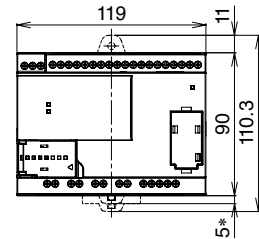

FT1A-H40*A/*C

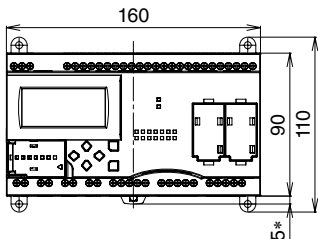

FT1A-H**A

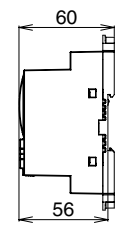

FT1A-H**C

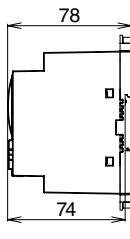

FT1A-B40*A/*C

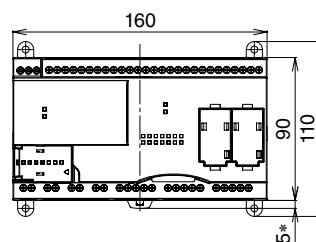

FT1A-B**A

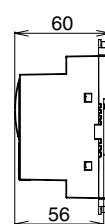

FT1A-B**C

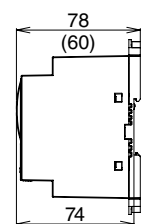

All dimensions in mm.

SmartAXIS Series FT1A Controller

FT1A-H48*A/*C

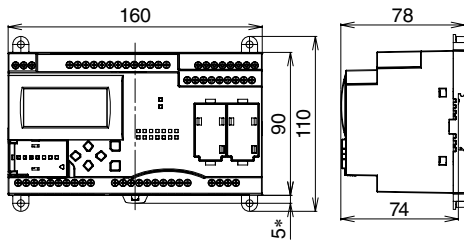

Note: 9.3 mm when the clamp is pulled out.

FT1A-B48*A/*C

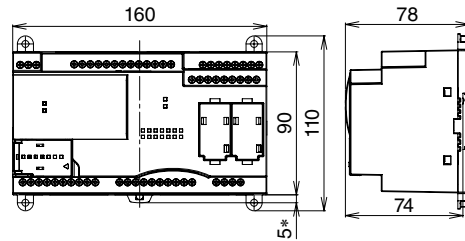

Note: 9.3 mm when the clamp is pulled out.

Mounting Hole Layout

Touch

FT1A-*12RA-*

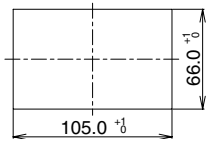

Pro/Lite

FT1A-*12**

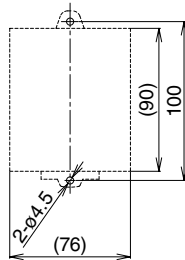

FT1A-*24**

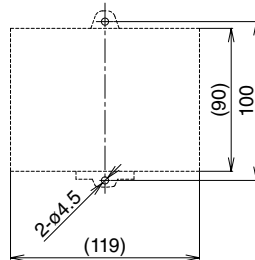

FT1A-*40**/FT1A-*48**

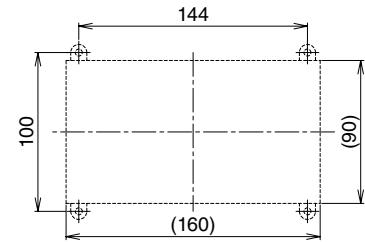

All dimensions in mm.

Recommended Ferrules for Touch/Pro/Lite

Cross Section (mm ²)	Cable Size	Phoenix Contact Part No. (Order No.)	
		For 1-wire connection	For 2-wire connection
0.25	AWG24	AI 0.25-8 YE (32 00 04 3)	-
0.5	AWG22	AI 0.5-8 WH (32 00 01 4)	AI-TWIN 2 x 0.5-8 WH (32 00 93 3)
0.75	AWG18	-	AI-TWIN 2 x 0.75-8 GY (32 00 80 7)
1.0	18	AI 1-8 RD (32 00 03 0)	-
1.5	16	AI 1.5-8 BK (32 00 04 3)	-

For 1-wire connection

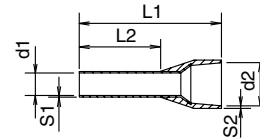

For 2-wire connection

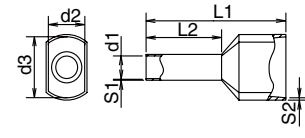

For 1-wire connection

Package Quantity: 1

Cross Section (mm ²)	Phoenix Contact Part No. (Order No.)	L1	L2	d1	S1	d2	S2
0.25	AI 0.25-8 YE (32 00 04 3)	12.5	8.0	0.8	0.15	1.8	0.25
0.5	AI 0.5-8 WH (32 00 01 4)	14.0	8.0	1.1	0.15	2.5	0.3
1.0	AI 1-8 RD (32 00 03 0)	14.5	8.0	1.5	0.15	3.0	0.3
1.5	AI 1.5-8 BK (32 00 04 3)	14.5	8.0	1.8	0.15	3.4	0.3

For 2-wire connection

Package Quantity: 1

Cross Section (mm ²)	Phoenix Contact Part No. (Order No.)	L1	L2	d1	S1	d2	d3	S2
2 x 0.5	AI-TWIN 2 x 0.5-8 WH (32 00 93 3)	15.0	8.0	1.5	0.15	2.5	4.6	0.25
2 x 0.75	AI-TWIN 2 x 0.75-8 GY (32 00 80 7)	15.0	8.0	1.8	0.15	2.7	5.2	0.3

Instructions

Basic Instructions (Touch/Pro/Lite)

Instructions	Function
LOD	Stores intermediate results and reads contact status
LODN	Stores intermediate results and reads inverted contact status
AND	Series connection of NO contact
ANDN	Series connection of NC contact
OR	Parallel connection of NO contact
ORN	Parallel connection of NC contact
ANDL0D	Series connection of circuit blocks
ORL0D	Parallel connection of circuit blocks
BPS	Saves the result of bit logical operation temporarily
BRD	Reads the result of bit logical operation which was saved temporarily
BPP	Restores the result of bit logical operation which was saved temporarily
OUT	Outputs the result of bit logical operation
OUTN	Output the inverted result of bit logical operation
SET	Sets output, internal relay, or shift register bit
RST	Resets output, internal relay, or shift register bit
TMS	Subtracting 1-ms on-delay timer (0 to 65.535 sec)
TMH	Subtracting 10-ms on-delay timer (0 to 655.35 sec)
TIM	Subtracting 100-ms on-delay timer (0 to 6553.5 sec)
TML	Subtracting 1-sec on-delay timer (0 to 65535 sec)
TMSO	Subtracting 1-ms off-delay timer (0 to 65.535 sec)
TMHO	Subtracting 10-ms off-delay timer (0 to 655.35 sec)

Instructions	Function
TIMO	Subtracting 100-ms off-delay timer (0 to 6553.5 sec)
TMLO	Subtracting 1-sec off-delay timer (0 to 65535 sec)
CNT	Adding counter (0 to 65,535)
CNTD	Double-word adding counter (0 to 4,294,967,295)
CDP	Dual pulse reversible counter (0 to 65,535)
CDPD	Double-word dual pulse reversible counter (0 to 4,294,967,295)
CUD	Up/down selection reversible counter (0 to 65,535)
CUDD	Double-word up/down selection reversible counter (0 to 4,294,967,295)
CC=	Equal to comparison of counter current value
CC≥	Greater than or equal to comparison of counter current value
DC=	Equal to comparison of data register value
DC≥	Greater than or equal to comparison of data register value
SFR	Forward shift register
SFRN	Reverse shift register
SOTU	Rising-edge differentiation output
SOTD	Falling-edge differentiation output
JMP	Jumps a designated program area
JEND	Ends a jump instruction
MCS	Starts a master control
MCR	Ends a master control
END	Ends a program

Advanced Instructions (Touch/Pro/Lite)

Instructions	Name
NOP	No Operation
MOV	Move
MOVN	Move Not
IMOV	Indirect Move
IMOVN	Indirect Move Not
IBMV	Indirect Bit Move
IBMVN	Indirect Bit Move Not
BMOV	Block Move
NSET	N Data Set
NRS	N Data Repeat Set
XCHG	Exchange
TCST	Timer/Counter Current Value Store
CMP=	Compare Equal To
CMP<>	Compare Unequal To
CMP<	Compare Less Than
CMP>	Compare Greater Than
CMP<=	Compare Less Than or Equal To
CMP>=	Compare Greater Than or Equal To
ICMP>=	Interval Compare Greater Than or Equal to
LC=	Load Compare Equal To
LC<>	Load Compare Unequal To
LC<	Load Compare Less Than
LC>	Load Compare Greater Than

Instructions	Name
LC<=	Load Compare Less Than or Equal To
LC>=	Load Compare Greater Than or Equal To
ADD	Addition
SUB	Subtraction
MUL	Multiplication
DIV	Division
INC	Increment
DEC	Decrement
ROOT	Root
SUM	Sum
RAD	Degree to Radian
DEG	Radian to Degree
SIN	Sine
COS	Cosine
TAN	Tangent
ASIN	Arc Sine
ACOS	Arc Cosine
ATAN	Arc Tangent
LOGE	Natural Logarithm
LOG10	Common Logarithm
EXP	Exponent
POW	Power
ANDW	AND Word

Instructions	Name
ORW	OR Word
XORW	Exclusive OR Word
SFTL	Shift Left
SFTR	Shift Right
BCDLS	BCD Left Shift
WSFT	Word Shift
ROTL	Rotate Left
ROTR	Rotate Right
HTOB	Hex to BCD
BTOH	BCD to Hex
HTOA	Hex to ASCII
ATOH	ASCII to Hex
BTOA	BCD to ASCII
ATOB	ASCII to BCD
ENCO	Encode
DECO	Decode
BCNT	Bit Count
ALT	Alternate Output
CVDT	Convert Data Type
DTDV	Data Divide
DTCB	Data Combine
SWAP	Data Swap

Advanced Instructions (Continued)

Instructions	Function	Touch	Pro/Lite			
		FT1A- *12RA-*	FT1A- *12***	FT1A- *24***	FT1A- *40***	FT1A- *48***
TXDn	Transmit	—	—	×	×	×
RXDn	Receive	—	—	×	×	×
ETXDn	Transmit over Ethernet	—	—	×	×	×
ERXDn	Receive over Ethernet	—	—	×	×	×
LABEL	Label	×	×	×	×	×
LJMP	Label Jump	×	×	×	×	×
LCAL	Label Call	×	×	×	×	×
LRET	Label Return	×	×	×	×	×
DJNZ	Decrement Jump Non-zero	×	×	×	×	×
MSG	Message	—	×	×	×	×
IOREF	I/O Refresh	×	(Pro only)	(Pro only)	(Pro only)	(Pro only)
HSCRFB	High-speed Counter Refresh	×	×	×	×	×
WEEK	Week Timer	×	×	×	×	×
YEAR	Yearly Timer	×	×	×	×	×
TADD	Time Addition	×	×	×	×	×
TSUB	Time Subtraction	×	×	×	×	×
HOUR	Hour Meter	×	×	×	×	×
HTOS	HMS to Sec	×	×	×	×	×
STOH	Sec to HMS	×	×	×	×	×
DTML	1-sec Dual Timer	×	×	×	×	×
DTIM	100-ms Dual Timer	×	×	×	×	×
DTMH	10-ms Dual Timer	×	×	×	×	×
DTMS	1-ms Dual Timer	×	×	×	×	×
TTIM	Teaching Timer	×	×	×	×	×
PULSn	Pulse Output	—	—	—	×	×
PWMn	Pulse Width Modulation	—	—	—	×	×
RAMPn	Ramp Pulse Output	—	—	—	×	×
ZRNn	Zero Return	—	—	—	×	×
ARAMPn	Advanced Ramp	—	—	—	×	×
DI	Disable Interrupt	×	×	×	×	×
EI	Enable Interrupt	×	×	×	×	×
XYFS	XY Format Set	×	×	×	×	×
CVXTY	Convert X to Y	×	×	×	×	×
CVYTX	Convert Y to X	×	×	×	×	×
AVRG	Average	×	×	×	×	×
FIFO	FIFO Format	×	×	×	×	×
FIEX	First-In Execute	×	×	×	×	×
FOEX	First-Out Execute	×	×	×	×	×
NDSRC	N Data Search	×	×	×	×	×
SCRPT (Note)	Script	×	×	×	×	×
DLOG	Data Logging	—	—	—	×	×
TRACE	Data Trace	—	—	—	×	×

×: Available, —: Not available

* DC power type only

Note: Available soon

SmartAXIS Series FT1A Controller

Terminal Arrangement and I/O Wiring Diagram Examples

FT1A-*12RC

Input Side

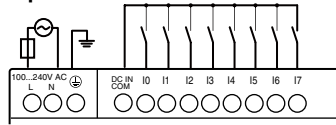

Output Side

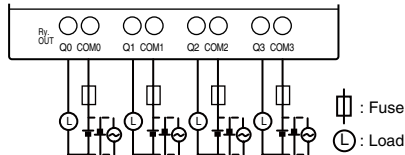

FT1A-*24RC

Input Side (sink/source)

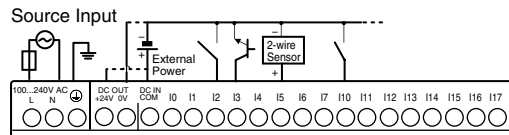

Sink Input

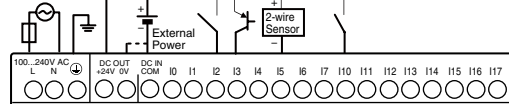

Output Side

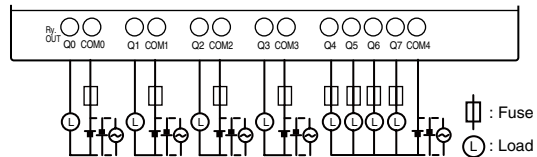

FT1A-*48SA

Input Side

Sink Input

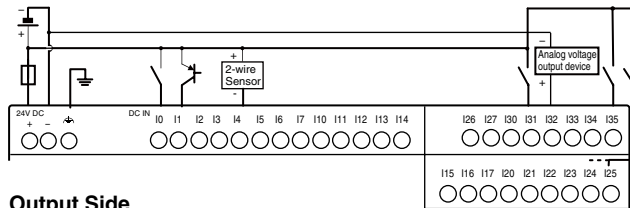

Output Side

Source Output

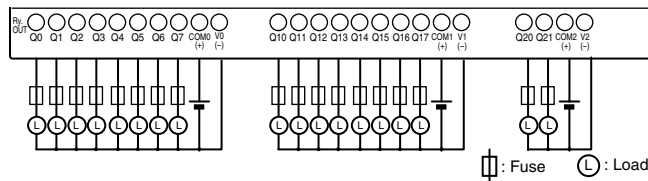

FT1A-*48KA

Input Side

Source Input (Analog/Digital Shared Input [] is Sink Input)

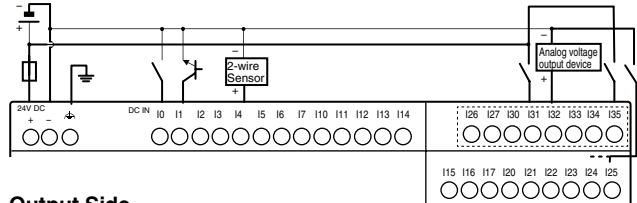

Output Side

Sink Output

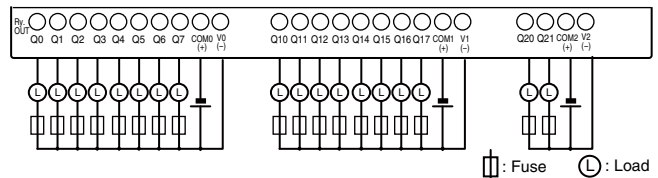

For terminal arrangement and I/O wiring diagram, see User's Manual.

Specifications and other descriptions in this catalog are subject to change without notice.



IDEC CORPORATION

6-64, Nishi-Miyahara 2-Chome, Yodogawa-ku, Osaka 532-0004, Japan
Tel: +81-6-6398-2571, Fax: +81-6-6392-9731
E-mail: marketing@idec.co.jp

IDEC CORPORATION (USA)

1175 Elko Drive
Sunnyvale, CA 94089-2209, USA
Tel: +1-408-747-0550 / (800) 262-IDEC (4332)
Fax: +1-408-744-9055 / (800) 635-6246
E-mail: opencontact@idec.com

IDEC CANADA LIMITED

3155 Pepper Mill Court, Unit 4
Mississauga, Ontario, L5L 4X7, Canada
Tel: +1-905-890-8561
Toll Free: (800) 262-IDEC (4332)
Fax: +1-905-890-8562
E-mail: sales@ca.idec.com

IDEC AUSTRALIA PTY. LTD.

Unit 17, 104 Ferntree Gully Road,
Oakleigh, Victoria 3166, Australia
Tel: +61-3-8523-5900, Toll Free: 1800-68-4332
Fax: +61-3-8523-5999
E-mail: sales@au.idec.com

IDEC ELECTRONICS LIMITED

Unit 2, Beechwood, Chineham Business Park,
Basingstoke, Hampshire RG24 8WA, UK
Tel: +44-1256-321000, Fax: +44-1256-327755
E-mail: sales@uk.idec.com

IDEC ELEKTROTECHNIK GmbH

Wendenstrasse 331, 20537 Hamburg, Germany
Tel: +49-40-25 30 54 - 0, Fax: +49-40-25 30 54 - 24
E-mail: service@idec.de

IDEC (SHANGHAI) CORPORATION

Room 701-702 Chong Hing Finance Center,
No. 288 Nanjing Road West, Shanghai 200003, PRC
Tel: +86-21-6135-1515
Fax: +86-21-6135-6225 / +86-21-6135-6226
E-mail: idec@cn.idec.com

IDEC (BEIJING) CORPORATION

Room 211B, Tower B, The Grand Pacific Building,
8A Guanghua Road, Chaoyang District,
Beijing 100026, PRC
Tel: +86-10-6581-6131, Fax: +86-10-6581-5119

IDEC (SHENZHEN) CORPORATION

Unit AB-3B2, Tian Xiang Building, Tian'an Cyber Park,
Fu Tian District, Shenzhen, Guang Dong 518040, PRC
Tel: +86-755-8356-2977, Fax: +86-755-8356-2944

IDEC IZUMI (H.K.) CO., LTD.

Unit G & H, 26/F, MG Tower, No. 133 Hoi Bun Road,
Kwun Tong, Kowloon, Hong Kong
Tel: +852-2803-8989, Fax: +852-2565-0171
E-mail: info@hk.idec.com

IDEC TAIWAN CORPORATION

8F-1, No. 79, Hsin Tai Wu Road, Sec. 1,
Hsi-Chih District, 22101 New Taipei City, Taiwan
Tel: +886-2-2698-3929, Fax: +886-2-2698-3931
E-mail: service@tw.idec.com

IDEC IZUMI ASIA PTE. LTD.

No. 31, Tannery Lane #05-01,
HB Centre 2, Singapore 347788
Tel: +65-6746-1155, Fax: +65-6844-5995
E-mail: info@sg.idec.com